

Article number: 439000060

Description: Rota-fix shaft-hub connection G60x90

Note: Self centering - very high torque

Measures

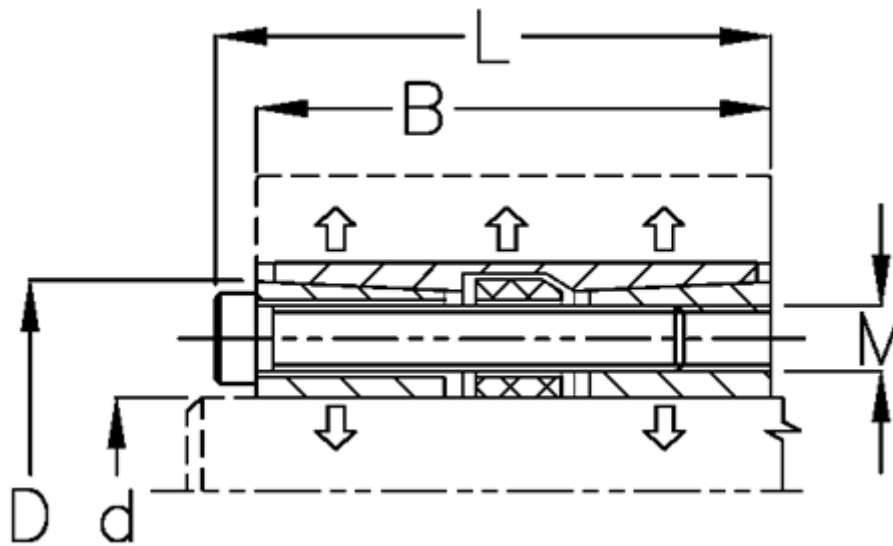

B mm	= 78
d H8 mm	= 60
D mm	= 90
Fit tolerance	= Aksel h8, Nav H8
F kN torque	= 220
L mm	= 86
M mm	= M8
P N/mm ² surface pressure on shaft/hub	= 75

Surface roughness	= R? ? 3.2 μm
T N m torque	= 5400
Ts N m bolt tightening torque	= 41